

LM-PB-X SERIES

Linear Motion Technology

LM-PB-X Coil Assembly Model

Coil Assembly Model	LM-PB-X2		LM-PB-X3		LM-PB-X4			LM-PB-X5		LM-PB-X6		LM-PB-X8			
Winding code	W1	W2	W1	W2	W1	W2	W3	W1	W2	W1	W2	W1	W2	W3	W4
Performance⁽¹⁾															
Peak force(N) ⁽¹⁾⁽²⁾	227		340.6		431.4			539.2		613					771.9
Continuous force with heat sink(N) ⁽¹⁾⁽²⁾	56.8		85.1		107.8			134.8		153.3					193
Continuous force without heat sink(N) ⁽²⁾⁽³⁾	42.6		59.6		73.8			92.2		110.7					147.6
Peak power(W) ⁽¹⁾⁽²⁾	1056		1584		1906.1			2382.6		2566.1					3051.8
Continuous power(W) ⁽¹⁾⁽²⁾	66		99		119.1			148.9		160.4					190.7
Mechanical															
Coil assembly length(mm)	80		110		140			170		200					260
Coil assembly weight(kg) ⁽²⁾	0.33		0.44		0.55			0.72		0.9					1.09
Magnetic way weight(kg/m) ⁽²⁾	12.2		12.2		12.2			12.2		12.2					12.2
Pole pitch(mm)	30		30		30			30		30					30
Electrical⁽⁴⁾															
Continuous current with heat sink(A _{pk}) ⁽¹⁾⁽²⁾	2	4	2	4	1.9	3.8	7.6	1.9	3.8	1.8	3.6	1.7	3.4	6.8	13.6
Continuous current without heat sink(A _{pk}) ⁽²⁾⁽³⁾	1.5	3	1.4	2.8	1.3	2.6	5.2	1.3	2.6	1.3	2.6	1.3	2.6	5.2	10.4
Peak current ⁽¹⁾⁽²⁾	8	16	8	16	7.6	15.2	30.4	7.6	15.2	7.2	14.4	6.8	13.6	27.7	54.4
Force constant(N/A _{pk}) ⁽²⁾	28.4	14.2	42.6	21.3	56.8	28.4	14.2	71	35.5	85.1	42.6	113.5	56.8	28.4	14.2
Back EMF constant(V _{pk(Hz)} / m/s) ⁽²⁾	33	16.5	49.5	24.8	66	33	16.5	82.5	41.3	99	49.5	132	66	33	16.5
Resistance(Ohms) ⁽²⁾	16.5	4.1	24.8	6.2	33	8.3	2.1	41.3	10.3	49.5	12.4	66	16.5	4.1	1
Inductance(mH) ⁽²⁾	5.74	1.44	8.61	2.15	11.48	2.87	0.72	14.35	3.59	17.22	4.31	22.96	5.74	1.44	0.36
Time constant(ms) ⁽²⁾	0.35	0.35	0.35	0.35	0.35	0.35	0.35	0.35	0.35	0.35	0.35	0.35	0.35	0.35	0.35
Thermal resistance with heat sink(°C/W) ⁽¹⁾⁽²⁾	1.3		0.8		0.7			0.5		0.5					0.4
Thermal resistance without heat sink(°C/W) ⁽²⁾⁽³⁾	2.3		1.7		1.5			1.2		1					0.7
Heat sink(mm)	250x250x25		250x250x25		250x250x25			250x250x25		250x250x25		250x250x25			
Motor constant(N·s/W) ⁽²⁾	7		8.6		9.9			11		12.1		14			
Ph-PE dielectric strength ⁽²⁾	≥ 5KV(AC)		≥ 5KV(AC)		≥ 5KV(AC)			≥ 5KV(AC)		≥ 5KV(AC)		≥ 5KV(AC)			
Ph-PE insulation resistance ⁽²⁾	≥ 1KV(DC)		≥ 1KV(DC)		≥ 1KV(DC)			≥ 1KV(DC)		≥ 1KV(DC)		≥ 1KV(DC)			

- (1) Value applies to the static sinusoidal drive, under specific heat sink and temperatures from 25°C to 110°C. Actual performance depends on heat sink configuration, system cooling conditions and the ambient temperature.
- (2) The tolerance of all performance and electrical specification is ±10%.
- (3) The value applies to the static sinusoidal drive at temperatures from 25°C up to 110°C, without heat sink.
- (4) The above "without heat sink" figure assumes a working condition of 1atm at a 25°C ambient temperature, with the stationary linear motor not in contact with any other objects, relying only on air convection for cooling. As all heat conductive objects in direct contact with the linear motor, including the sliding plate, linear guide, and base, can be considered a type of heat sink, the "with heat sink" figure should be taken as the primary reference for actual application design.

LM-PB-X Coil Assembly

	Np1	Np2	Lp	Mp	A	B	C	D
LM-PB-X2	1	1	80	74	5	10	25	20
LM-PB-X3	1	1	110	104	25	35	35	25
LM-PB-X4	2	2	140	134	5	15	35	25
LM-PB-X5	2	2	170	164	35	45	35	25
LM-PB-X6	3	3	200	194	15	25	35	25
LM-PB-X8	4	4	260	254	25	35	35	25

LM-SB-X Magnetic Way

	Ns	Ls
LM-SB-X0	1	120
LM-SB-X1	4	300
LM-SB-X2	7	480

LM-PB-X Coil Assembly

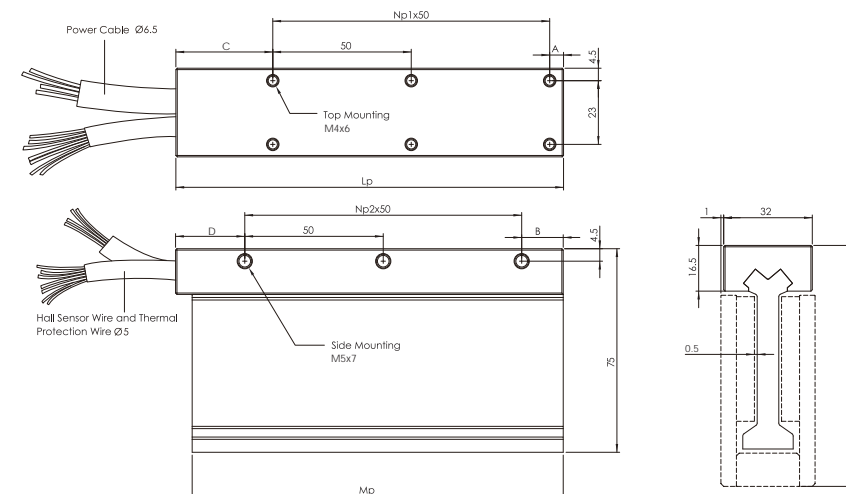

LM-SB-X Magnetic Way

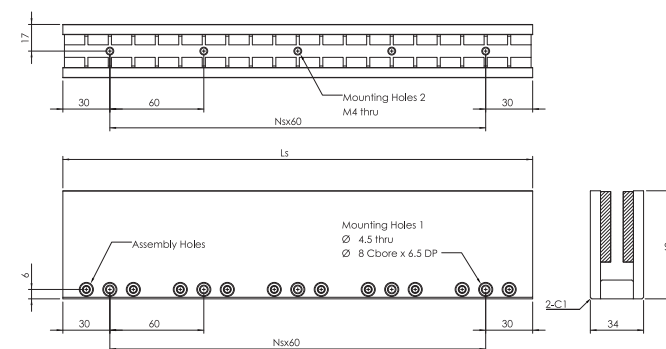

OUTPUT CABLE (All cable standard length is 400 mm)

Motor Wire Table				Hall Sensor Wire Table and Thermal Protection Wire Table				
Pin Number	Function	Cross section	Color	Function	Cable Dia.	Color	Function	Cable Dia.
	U phase	0.5 mm ²	Pink	Hall A U phase	0.14 mm ²	Brown		
	V phase	0.5 mm ²	Yellow	Hall B V phase	0.14 mm ²	Blue	Thermal sensor	0.14 mm ²
	W phase	0.5 mm ²	Green	Hall C W phase	0.14 mm ²			
	PE + shielding	0.5 mm ²	Grey	Hall IC + 5V	0.14 mm ²		Shielding	
			White	GND	0.14 mm ²			

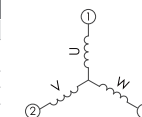

Sizing Example

Condition 1: Motion profile containing cruising section

Driver maximum output voltage : 300Vdc

Driver continuous output current : 2A

Driver peak output current : 5A

Max. velocity : $V_{max} = 2$ [m/s]

Cruising time : $t_2 = 3$ [s]

Load mass : $m = 5$ [kg]

Decelerating time : $t_3 = 0.2$ [s]

Acceleration : $a = 10$ [m/s²]

Dwell time : $t_4 = 2$ [s]

Accelerating time : $t_1 = 0.2$ [s]

Friction Force : $f = 5$ [N]

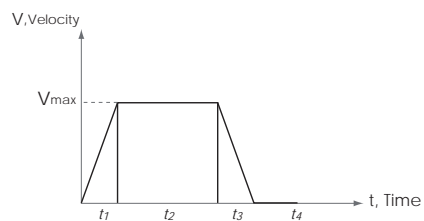

Symbol	Parameter	Metric	Imperial
t_1	Accelerating time	s	s
t_2	Cruising time	s	s
t_3	Decelerating time	s	s
t_4	Dwell time	s	s
V_{max}	Max. velocity	m/S	in/S

Step1: Thrust force calculation

$$F_1 = ma + f = 5 \times 10 + 5 = 55 \text{ [N]}$$

$$F_2 = f = 5 \text{ [N]}$$

$$F_3 = ma - f = 5 \times 10 - 5 = 45 \text{ [N]}$$

$$F_4 = 0 \text{ [N]}$$

$$F_{rms} = \sqrt{\frac{F_1^2 \times t_1 + F_2^2 \times t_2 + F_3^2 \times t_3 + F_4^2 \times t_4}{t_1 + t_2 + t_3 + t_4}}$$

$$= \sqrt{\frac{55^2 \times 0.2 + 5^2 \times 3 + 45^2 \times 0.2 + 0}{0.2 + 3 + 0.2 + 2}} = 14.2 \text{ [N]}$$

$$F_{max} = F_1 = 55 \text{ [N]}$$

$$\text{Safety factor} = 1.5$$

Motor required peak force needs to be greater than

$$F_{max} \times 1.5 = 55 \times 1.5 = 82.5 \text{ [N]}$$

Motor required continuous force needs to be greater than

$$F_{rms} \times 1.5 = 14.2 \times 1.5 = 21.3 \text{ [N]}$$

Hence choose LM-PA-X2

(Peak Force= 123.8[N], Continuous force = 31[N])

Step2: Wiring selection

If W1 model is chosen

$$I_{rms} = F_{rms} / K_f = 21.3 / 17.2 = 1.24 \text{ [A]}$$

$$I_{max} = F_{max} / k_f = 82.5 / 17.2 = 4.8 \text{ [A]}$$

$$\text{Required voltage} = V_{max} \times K_e + I_{max} \times R$$

$$= 2 \times 20 + 4.8 \times 17 = 121.6 \text{ [V]}$$

$$\text{Take safety factor} = 1.3$$

$$\text{Required supply voltage } 121.6 \times 1.3 = 158.1 \text{ [V]}$$

Driver :

Continuous output current 2A > 1.24A

Peak output current 5A > 4.8A

Max. output voltage 300V > 158.1V

W1 model matches requirements.

LM-PA-X2-W1 will be applicable.

Condition 2 : Motion Profile without cruising velocity section

Driver maximum output voltage : 80Vdc

Driver continuous output current : 2A

Driver peak output current : 4A

Load mass : 5 [kg]

Moving Time : $T = 1$ [s]

Stroke : $S = 1$ [m]

Friction Force : $f = 5$ [N]

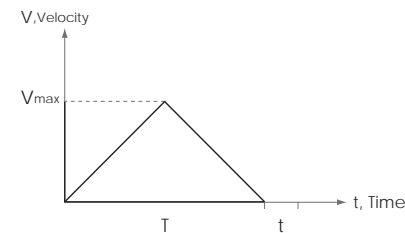

Symbol	Parameter	Metric	Imperial
t	Stop time	s	s
T	Moving time	s	s
V_{max}	Max. velocity	m/s	in/s
a	Acceleration	m/s ²	in/s ²
s	Stroke	m	in

Step1: Thrust force calculation

$$a = 4S/T^2 = 4 \times 1/1 = 4 \text{ m/s}^2$$

$$F_1 = ma + f = 5 \times 4 + 5 = 25 \text{ [N]}$$

$$F_2 = ma - f = 5 \times 4 - 5 = 15 \text{ [N]}$$

$$F_3 = 0 \text{ [N]}$$

$$F_{rms} = \sqrt{\frac{F_1^2 \times t_1 + F_2^2 \times t_2 + F_3^2 \times t_3}{t_1 + t_2 + t_3}}$$

$$F_{rms} = \sqrt{\frac{25^2 \times 0.5 + 15^2 \times 0.5 + 0}{0.5 + 0.5 + 0.2}} = 18.8 \text{ [N]}$$

$$F_{max} = F_1 = 25 \text{ [N]}$$

$$\text{Safety factor} = 1.5$$

Motor required peak force needs to be greater than

$$F_{max} \times 1.5 = 25 \times 1.5 = 37.5 \text{ [N]}$$

Motor required continuous force needs to be greater than

$$F_{rms} \times 1.5 = 18.8 \times 1.5 = 28.2 \text{ [N]}$$

Hence choose LM-PA-X4

(Peak Force= 151.4[N], Continuous force = 37.8[N])

Step2: Wiring selection

If W1 model is chosen

$$I_{rms} = F_{rms} / K_f = 18.8 / 34.4 = 0.55 \text{ [A]}$$

$$I_{max} = F_{max} / K_f = 25 / 34.4 = 0.73 \text{ [A]}$$

$$V_{max} = T/2 \times a = 1/2 \times 4 = 2 \text{ [m/s]}$$

$$\text{Required voltage} = V_{max} \times K_e + I_{max} \times R$$

$$= 2 \times 40 + 0.73 \times 34 = 104.8 \text{ [V]}$$

$$\text{Take safety factor} = 1.3$$

$$\text{Required supply voltage } 104.8 \times 1.3 = 136.2 \text{ [V]}$$

Driver :

Continuous output current 2A > 0.55A

Peak output current 4A > 0.73A

Max. output voltage 80V < 136.2V

Max. velocity cannot be reached with W1.

If W2 model is chosen

$$I_{rms} = F_{rms} / K_f = 18.8/17.2 = 1.1 \text{ [A]}$$

$$I_{max} = F_{max} / K_f = 25/17.2 = 1.45 \text{ [A]}$$

$$\text{Required voltage} = V_{max} \times K_e + I_{max} \times R$$

$$= 2 \times 20 + 1.45 \times 8.5 = 52.3 \text{ [V]}$$

$$\text{Take safety factor} = 1.3$$

$$\text{Required supply voltage } 52.3 \times 1.3 = 68 \text{ [V]}$$

Driver :

Continuous output current 2A > 1.1A

Peak output current 4A > 1.45A

Max. output voltage 80V > 68V

W2 model matches requirements.

LM-PA-X4-W2 will be applicable.

Note: For other calculation constraints or special requirements please contact [cpc](#).

Sizing Form

Customer Name /	Filling Date (DD/MM/YEAR) /
Contact Person /	Telephone /
E-mail /	Fax /

1. Point-to-point motion without constant velocity

Property: Specific travel distance in specific time
 Application: Pick and place, carriage etc.

a. Known Motion Condition	
(1) Load mass	kg
(2) Effective stroke	m
(3) Moving time	s
(4) Dwell time	s

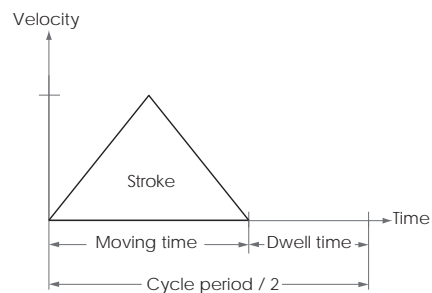

b. Driver Condition	
(1) Max. output voltage	V
(2) Continuous current	A
(3) Peak current	A

c. Encoder	
(1) <input type="checkbox"/> Analog <input type="checkbox"/> Digital	
(2) Resolution	μm

f. Motion Direction	
(1) <input type="checkbox"/> Horizontal	
(2) <input type="checkbox"/> Vertical	
(3) <input type="checkbox"/> Tilt _____ degrees	

d. Working Environment	
(1) <input type="checkbox"/> Room temperature	
(2) <input type="checkbox"/> Constant temperature _____°C	
(3) <input type="checkbox"/> Vacuum _____ Torr	
(4) <input type="checkbox"/> Clean room _____ level	

g. Installation Method	
(1) <input type="checkbox"/> Lying flat	
(2) <input type="checkbox"/> Vertically standing	
(3) <input type="checkbox"/> Wall mount	

e. Motion Precision	
(1) Positioning accuracy	μm
(2) Repetitive accuracy	μm

h. Space Restrictions	
(1) <input type="checkbox"/> None	
(2) <input type="checkbox"/> Yes _____mm x _____mm x _____mm	

Sizing Form

Customer Name /	Filling Date (DD/MM/YEAR) /
Contact Person /	Telephone /
E-mail /	Fax /

2. Point-to-Point Motion without constant velocity

Property: Specific travel distance in specific time
 Application: Pick and place, carriage etc.

a. Known Motion Condition	
(1) Load mass	kg
(2) Effective stroke	m
(3) Frequency	Hz
(4) Dwell time	s

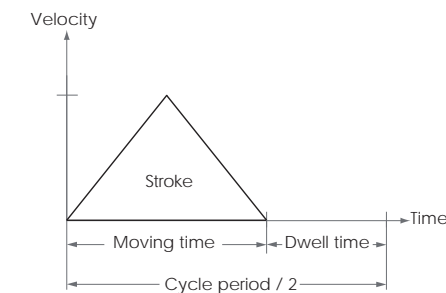

b. Driver Condition	
(1) Max. output voltage	V
(2) Continuous current	A
(3) Peak current	A

c. Encoder	
(1) <input type="checkbox"/> Analog <input type="checkbox"/> Digital	
(2) Resolution	μm

f. Motion Direction	
(1) <input type="checkbox"/> Horizontal	
(2) <input type="checkbox"/> Vertical	
(3) <input type="checkbox"/> Tilt _____ Degrees	

d. Working Environment	
(1) <input type="checkbox"/> Room temperature	
(2) <input type="checkbox"/> Constant temperature _____°C	
(3) <input type="checkbox"/> Vacuum _____ Torr	
(4) <input type="checkbox"/> Clean room _____ level	

g. Installation Method	
(1) <input type="checkbox"/> Lying flat	
(2) <input type="checkbox"/> Vertically standing	
(3) <input type="checkbox"/> Wall mount	

e. Motion Precision	
(1) Positioning accuracy	μm
(2) Repetitive accuracy	μm

h. Space Restrictions	
(1) <input type="checkbox"/> None	
(2) <input type="checkbox"/> Yes _____mm x _____mm x _____mm	

Sizing Form

Customer Name /	Filling Date (DD/MM/YEAR) /
Contact Person /	Telephone /
E-mail /	Fax /

3. Point-to-Point Motion without constant velocity

Property: Specific travel distance in specific time
Application: Pick and place, carriage etc.

a. Known Motion Condition	
(1) Load mass	kg
(2) Effective stroke	m
(3) Acceleration	m/s ²
(4) Dwell time	s

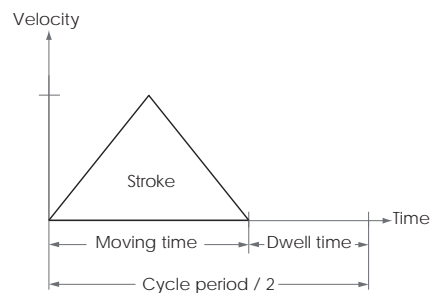

b. Driver Condition	
(1) Max. output voltage	V
(2) Continuous current	A
(3) Peak current	A

c. Encoder	
(1) <input type="checkbox"/> Analog <input type="checkbox"/> Digital	
(2) Resolution	μm

f. Motion Direction	
(1) <input type="checkbox"/> Horizontal	
(2) <input type="checkbox"/> Vertical	
(3) <input type="checkbox"/> Tilt _____ degrees	

d. Working Environment	
(1) <input type="checkbox"/> Room temperature	
(2) <input type="checkbox"/> Constant temperature _____°C	
(3) <input type="checkbox"/> Vacuum _____ Torr	
(4) <input type="checkbox"/> Clean room _____ level	

g. Installation Method	
(1) <input type="checkbox"/> Lying flat	
(2) <input type="checkbox"/> Vertically standing	
(3) <input type="checkbox"/> Wall mount	

e. Motion Precision	
(1) Positioning accuracy	μm
(2) Repetitive accuracy	μm

h. Space Restrictions	
(1) <input type="checkbox"/> None	
(2) <input type="checkbox"/> Yes _____mm x _____mm x _____mm	

Sizing Form

Customer Name /	Filling Date (DD/MM/YEAR) /
Contact Person /	Telephone /
E-mail /	Fax /

4. Point-to-Point Motion with constant velocity

Property: Work performed under constant velocity
Application: Scanning, inspection, cutting etc.

a. Motion Condition	
(1) Load mass	kg
(2) Effective stroke	m
(3) Moving time	s
(4) Dwell time	s
(5) Acceleration	m/s ²

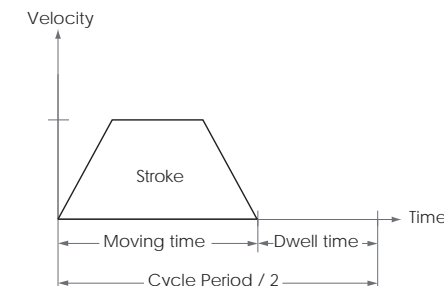

b. Driver Condition	
(1) Max. output voltage	V
(2) Continuous current	A
(3) Peak current	A

c. Encoder	
(1) <input type="checkbox"/> Analog <input type="checkbox"/> Digital	
(2) Resolution	μm

f. Motion Direction	
(1) <input type="checkbox"/> Horizontal	
(2) <input type="checkbox"/> Vertical	
(3) <input type="checkbox"/> Tilt _____ degrees	

d. Working Environment	
(1) <input type="checkbox"/> Room Temperature	
(2) <input type="checkbox"/> Constant Temperature _____°C	
(3) <input type="checkbox"/> Vacuum _____ Torr	
(4) <input type="checkbox"/> Clean room _____ level	

g. Installation Method	
(1) <input type="checkbox"/> Lying flat	
(2) <input type="checkbox"/> Vertically standing	
(3) <input type="checkbox"/> Wall mount	

e. Motion Precision	
(1) Positioning accuracy	μm
(2) Repetitive accuracy	μm

h. Space Restrictions	
(1) <input type="checkbox"/> None	
(2) <input type="checkbox"/> Yes _____mm x _____mm x _____mm	

Sizing Form

Customer Name /	Filling Date (DD/MM/YEAR) /
Contact Person /	Telephone /
E-mail /	Fax /

5. Point-to-point motion with constant velocity

Property: Work performed under constant velocity
Application: Scanning, inspection, cutting etc.

a. Motion Condition	
(1) Load mass	kg
(2) Effective stroke	m
(3) Max. velocity	m/s
(4) Acceleration time	s
(5) Dwell time	s

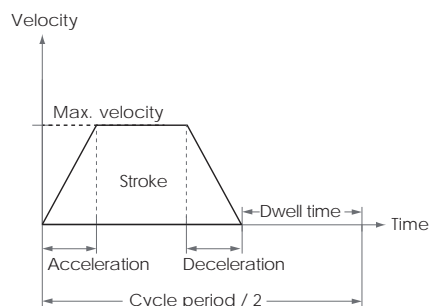

b. Driver Condition	
(1) Max. output voltage	V
(2) Continuous current	A
(3) Peak current	A

c. Encoder	
(1) <input type="checkbox"/> Analog <input type="checkbox"/> Digital	
(2) Resolution	μm

d. Working Environment	
(1) <input type="checkbox"/> Room temperature	
(2) <input type="checkbox"/> Constant temperature _____°C	
(3) <input type="checkbox"/> Vacuum _____ Torr	
(4) <input type="checkbox"/> Clean room _____ level	

e. Motion Precision	
(1) Positioning accuracy	μm
(2) Repetitive accuracy	μm

f. Motion Direction	
(1) <input type="checkbox"/> Horizontal	
(2) <input type="checkbox"/> Vertical	
(3) <input type="checkbox"/> Tilt _____ degrees	

g. Installation Method	
(1) <input type="checkbox"/> Lying flat	
(2) <input type="checkbox"/> Vertically standing	
(3) <input type="checkbox"/> Wall mount	

h. Space Restrictions	
(1) <input type="checkbox"/> None	
(2) <input type="checkbox"/> Yes _____mm x _____mm x _____mm	

Sizing Form

Customer Name /	Filling Date (DD/MM/YEAR) /
Contact Person /	Telephone /
E-mail /	Fax /

6. Point-to-Point Motion with constant velocity section

Property: Work performed under constant velocity
Application: Scanning, inspection, cutting etc.

a. Motion Condition	
(1) Load mass	kg
(2) Effective stroke	m
(3) Moving time	s
(4) Acceleration	m/s ²
(5) Dwell time	s

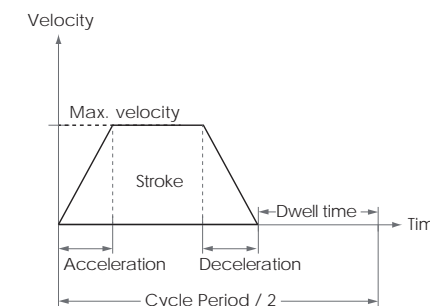

b. Driver Condition	
(1) Max. output voltage	V
(2) Continuous current	A
(3) Peak current	A

c. Encoder	
(1) <input type="checkbox"/> Analog <input type="checkbox"/> Digital	
(2) Resolution	μm

d. Working Environment	
(1) <input type="checkbox"/> Room temperature	
(2) <input type="checkbox"/> Constant temperature _____°C	
(3) <input type="checkbox"/> Vacuum _____ Torr	
(4) <input type="checkbox"/> Clean room _____ level	

e. Motion Precision	
(1) Positioning accuracy	μm
(2) Repetitive accuracy	μm

f. Motion Direction	
(1) <input type="checkbox"/> Horizontal	
(2) <input type="checkbox"/> Vertical	
(3) <input type="checkbox"/> Tilt _____ degrees	

g. Installation Method	
(1) <input type="checkbox"/> Lying flat	
(2) <input type="checkbox"/> Vertically standing	
(3) <input type="checkbox"/> Wall mount	

h. Space Restrictions	
(1) <input type="checkbox"/> None	
(2) <input type="checkbox"/> Yes _____mm x _____mm x _____mm	